



## COVERCART (4 FILAS/ROWS)

REF. R60043





- 

Dimensiones estándar: 4991 x 2600 x H2322 mm  
Standard dimensions: 4991 x 2600 x H2322 mm
- 

Cobijo para 4 filas de carros  
4-row parking bay
- 

Tubos exteriores de la estructura: 140 x 60 mm  
External pipes of the structures: 140 x 60 mm  
Tubos interiores: 60 x 60 mm  
Inner tubes: 60 x 60 mm
- 

Espesor: 2 mm  
Thickness: 2 mm
- 

Barras superiores de techo: 30 x 30 mm  
Top roof bars: 30 x 30 mm
- 

Material de la estructura: Acero carbono con pintura epoxi poliéster  
Structure material: Carbon steel structure with epoxy polyester paint  
Material de los paneles: paneles laterales de policarbonato de 8 mm y paneles del techo de policarbonato celular.  
Panels material: 8 mm polycarbonate side panels and cell polycarbonate roof panels.
- 

Producto personalizable en múltiples colores  
Customizable product with multiple colors available



**Covercart (4 filas/Rows)**

Dibujo técnico  
Technical design

REF. R60043

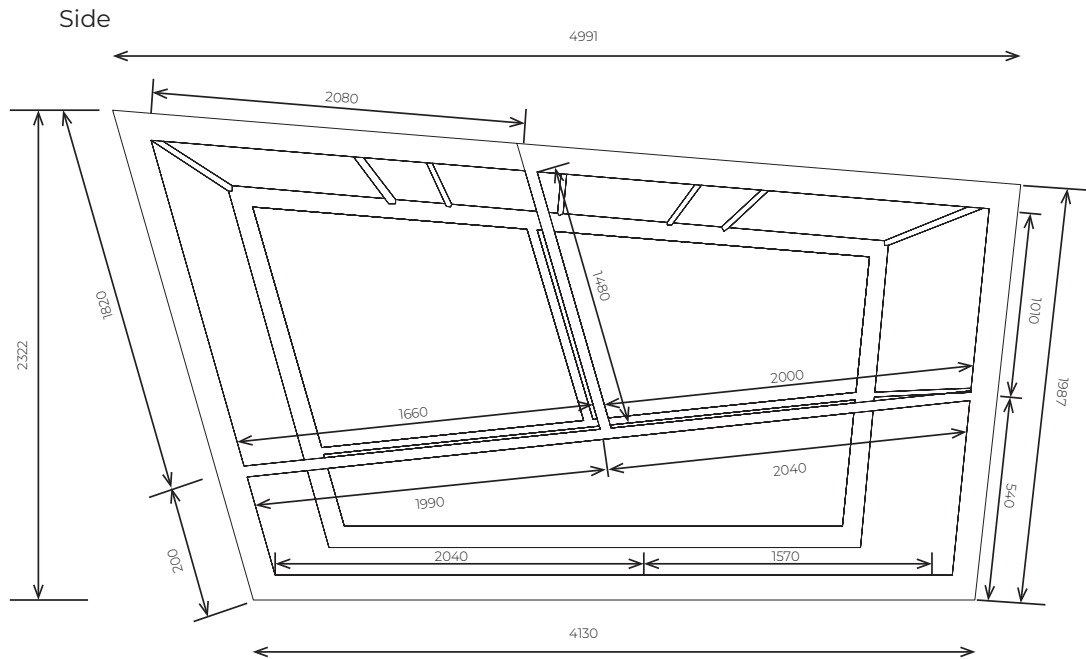

Back

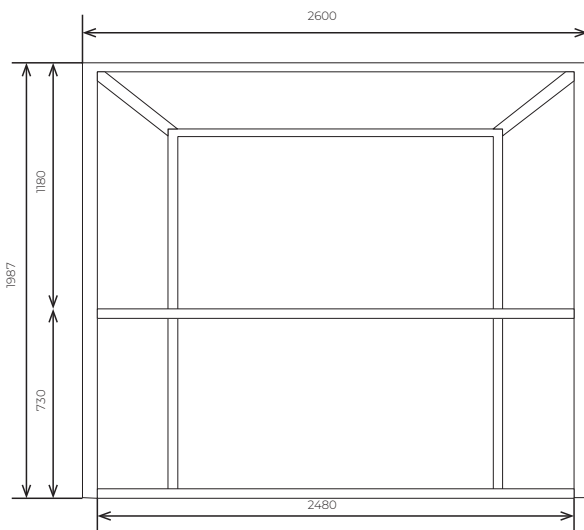

Front

